

3701 MIRAMAR

TERRACE

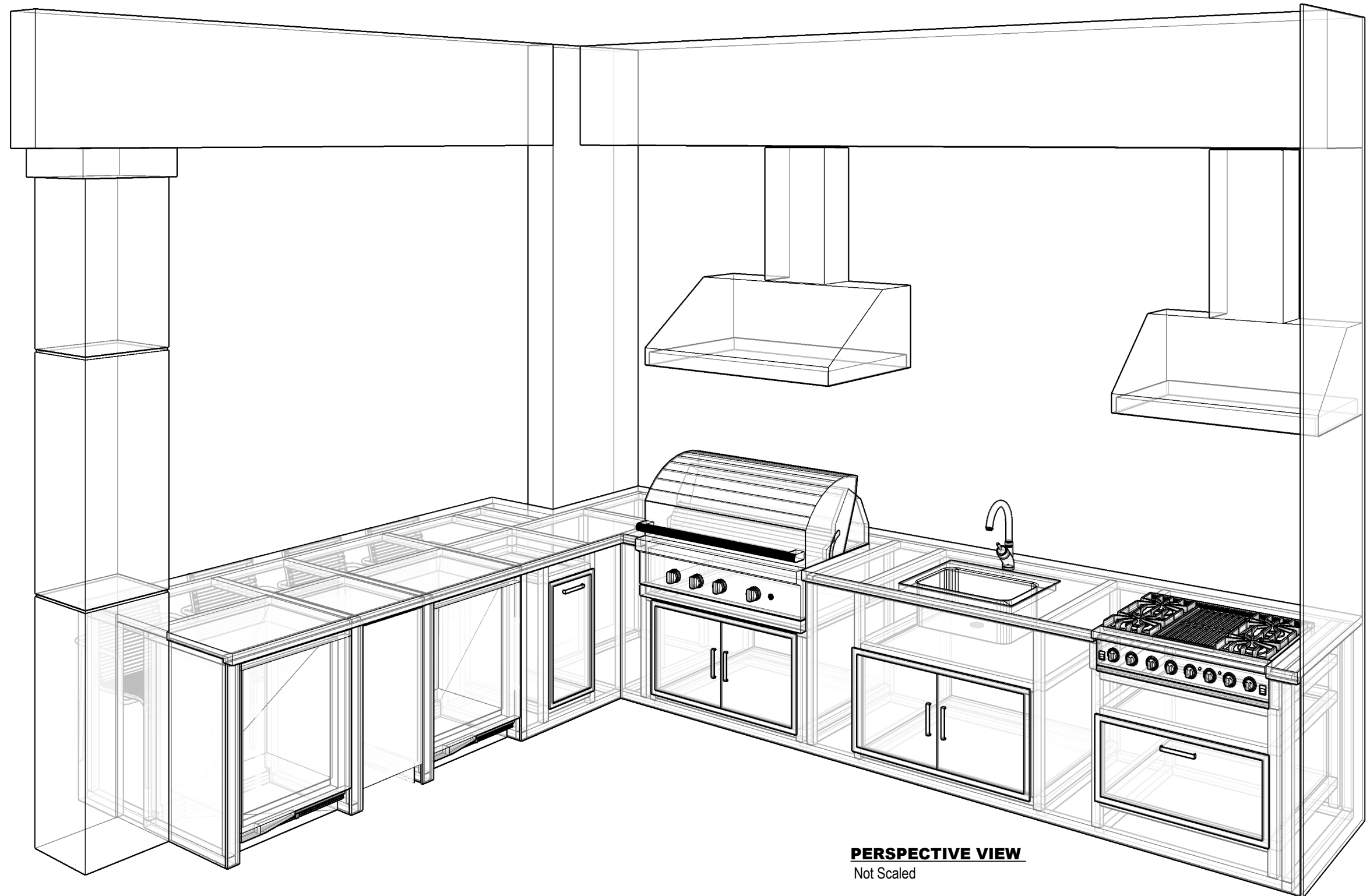

PERSPECTIVE VIEW

Not Scaled

PROGRESS DRAWING

This presentation is not intended to be used for contract pricing or fabrication purposes. All content is subject to change.

DISCARD ALL PRESENTATIONS THAT WERE MADE ON THIS ITEM PRIOR TO THE DATE BELOW:

02/18/2022

NOTES

The drawings included in presentations may not be scaled. The numerical dimensions represent correct measurements. All dimensions are given from finished floor and finished wall unless otherwise noted. All design ideas, drawings and plans represented here are owned by the property of **WESTHAVEN CONSTRUCTION SERVICES**. Above suggested electrical and plumbing locations, must be verified in field.

PROJECT

**3701
MIRAMAR**

PAGE NAME

Cover Page

DESIGN BY

J. ALONSO

DRAWING BY

A. QUINTERO

CREATED

01/ 27/ 2022

MODIFIED

02/18/2022

CLIENT

JOEL & YOLY ALONSO

ADDRESS

0000
FI, 33000



WESTHAVEN
CONSTRUCTION SERVICES, INC.

8254 NW SOUTH RIVER DRIVE, MEDLEY, FL 33166
All rights reserved.



PROGRESS DRAWING

ALL MEASUREMENTS MUST BE VERIFIED IN FIELD
This drawing is not intended to be used for contract pricing or fabrication purposes. All content is subject to change.

DISCARD ALL DRAWINGS THAT WERE MADE ON THIS ITEM PRIOR TO THE DATE BELOW:

02/18/2022

NOTES
Drawings may not be scaled. The numerical dimensions represent correct measurements. All dimensions are given from finished floor and finished wall unless otherwise noted. All design ideas, drawings and plans represented here are owned by the property of **WESTHAVEN CONSTRUCTION SERVICES**. All rights reserved. Above suggested electrical and plumbing locations, must be verified in field.

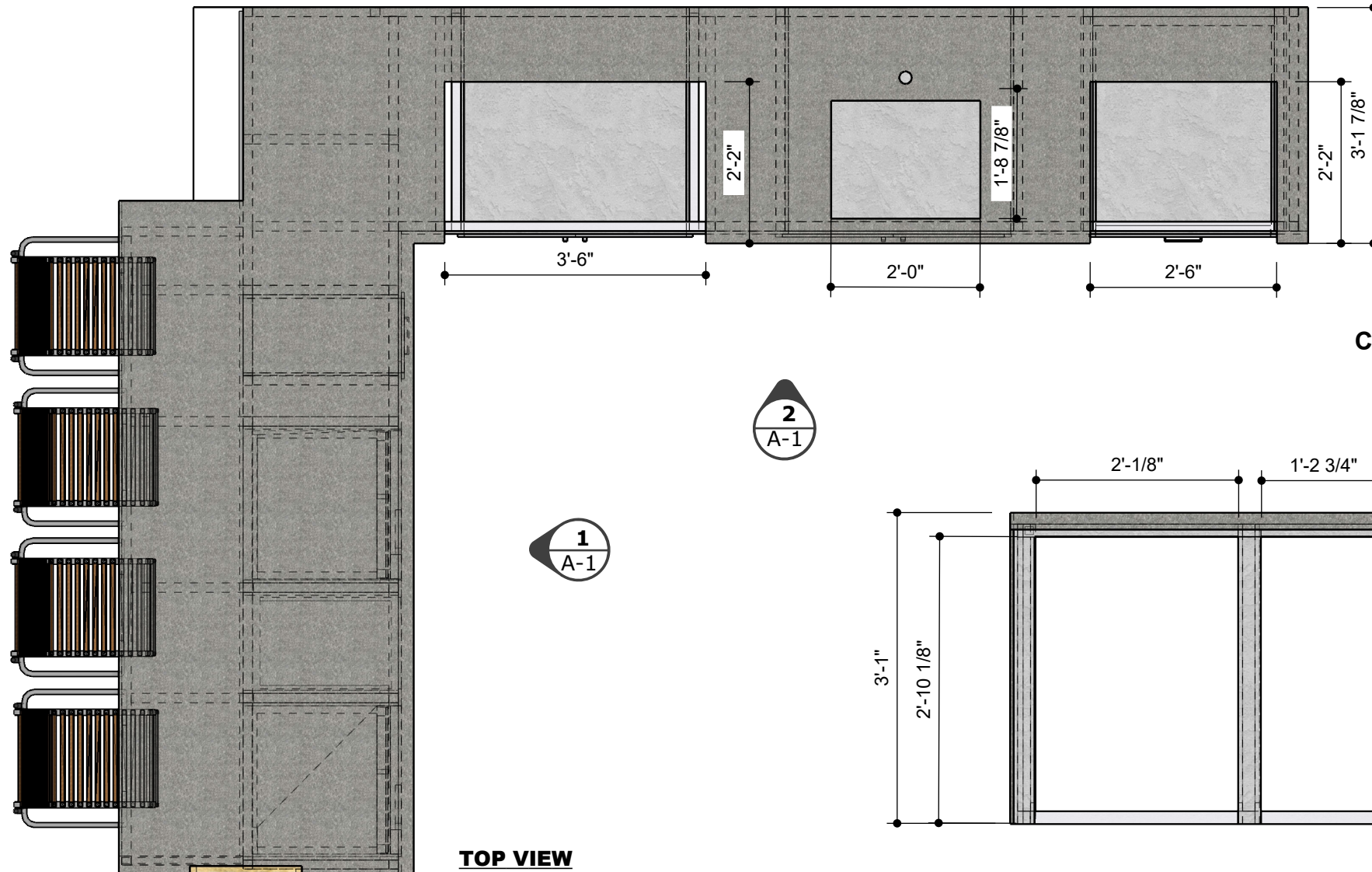

TOP VIEW
Scale 1:24

CUT OFF WIDTH HEIGHT & DEPTH

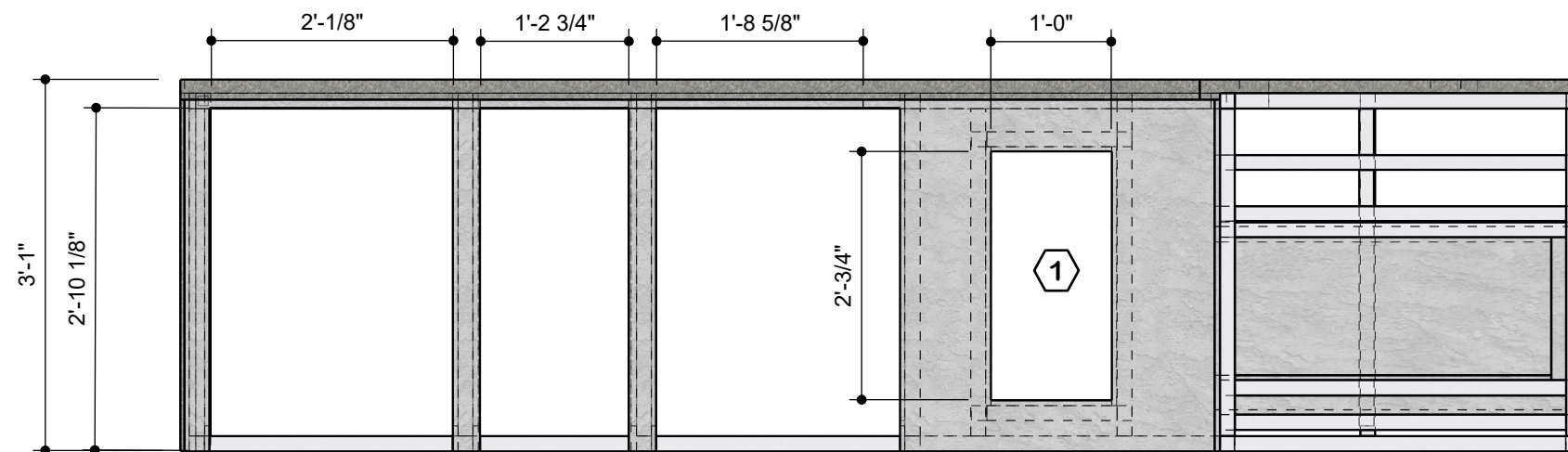

VIEW 1
Scale 1:24

~~2~~ **NUMBER 2 CANCELED**

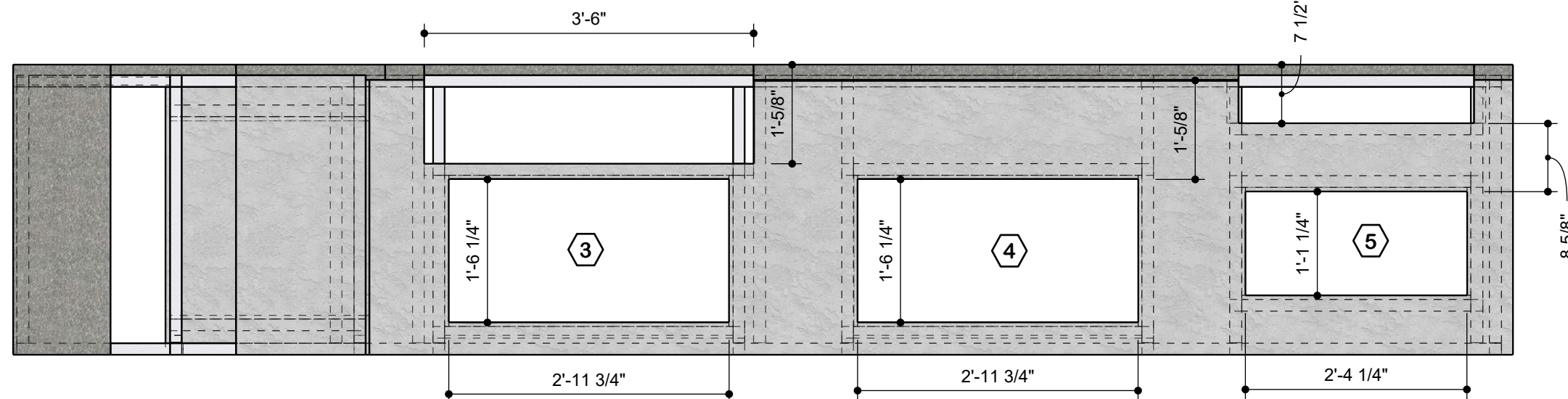

VIEW 2
Scale 1:24

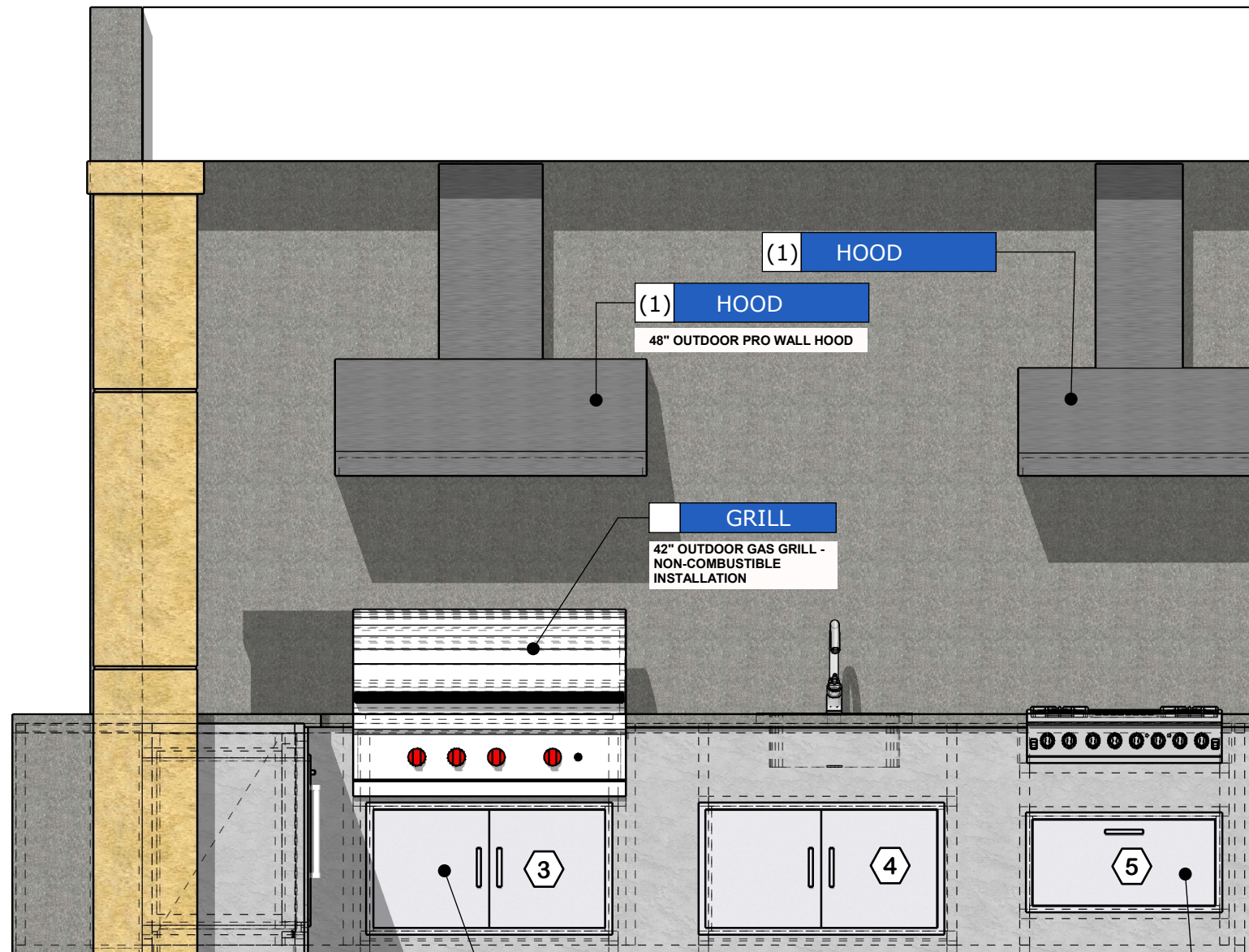

FRONT VIEW
Scale 1:24

3,4 ACCESS DOOR

*BBQGuys Signature
40-Inch Stainless
Steel Double Access
Door - Contempo
ID # 3073993*

ACCESS DRAWER

*BBQGuys Signature
30 X 15-Inch
Stainless Steel Single
Access Drawer -
Contempo
ID # 3074113*

(1) HOOD

(1) HOOD
48" OUTDOOR PRO WALL HOOD

GRILL
42" OUTDOOR GAS GRILL -
NON-COMBUSTIBLE
INSTALLATION

3

4

5

PROGRESS DRAWING

ALL MEASUREMENTS MUST BE VERIFIED IN FIELD

This drawing is not intended to be used for contract pricing or fabrication purposes. All content is subject to change.

DISCARD ALL DRAWINGS THAT WERE MADE ON THIS ITEM PRIOR TO THE DATE BELOW:

02/18/2022

NOTES

Drawings may not be scaled. The numerical dimensions represent correct measurements. All dimensions are given from finished floor and finished wall unless otherwise noted. All design ideas, drawings and plans represented here are owned by the property of WESTHAVEN CONSTRUCTION SERVICES. All rights reserved. Above suggested electrical and plumbing locations, must be verified in field.

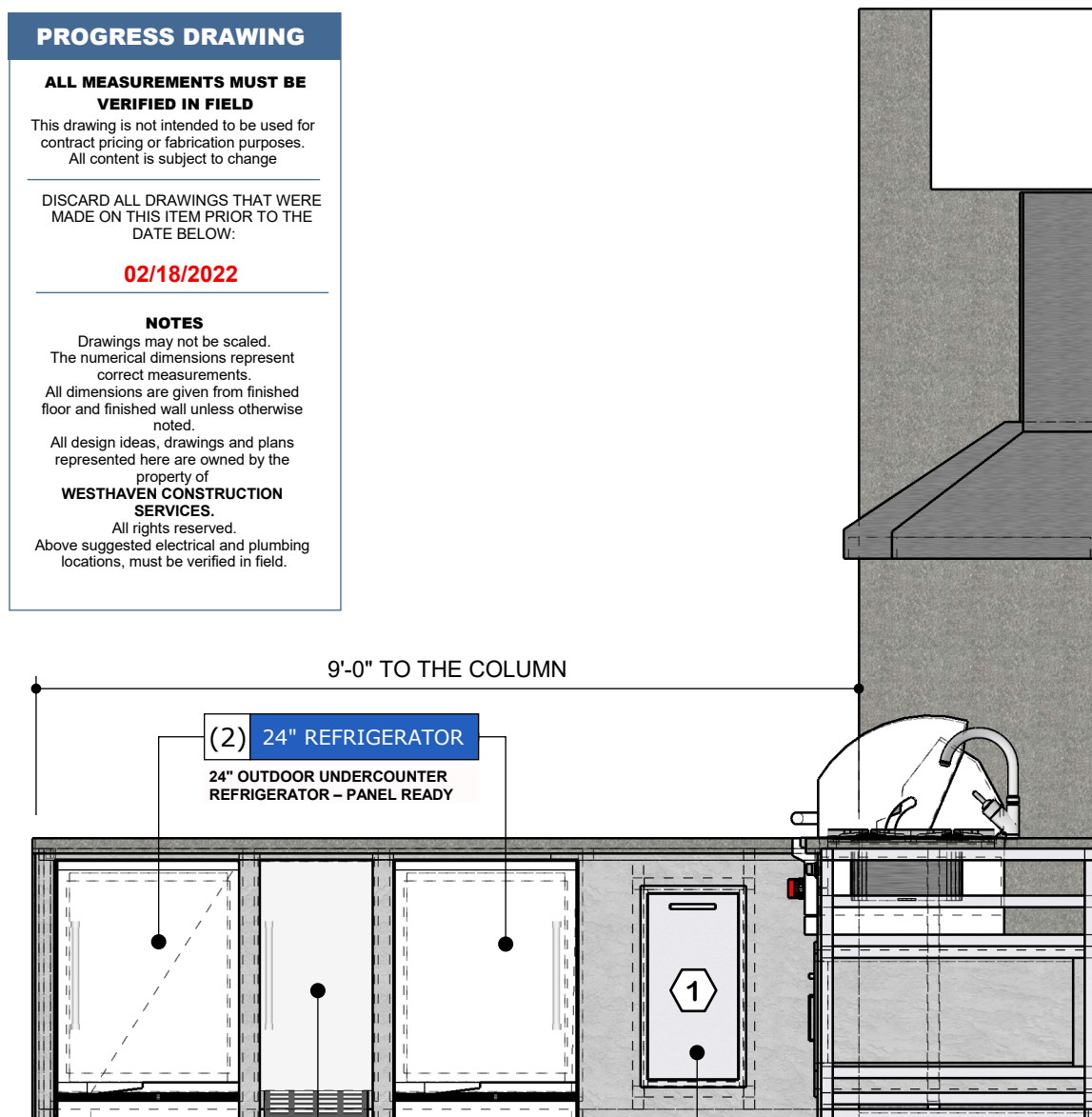

SIDE VIEW
Scale 1:24

(2) 24" REFRIGERATOR
24" OUTDOOR UNDERCOUNTER REFRIGERATOR - PANEL READY

9'-0" TO THE COLUMN

(1) 15" ICE MAKER
15" OUTDOOR ICE MAKER WITH PUMP - PANEL READY

TRASH BIN

*BBQGuys Signature
13-Inch Stainless
Steel Narrow Roll-Out
Trash Bin - Contempo
ID # 3074035*

1

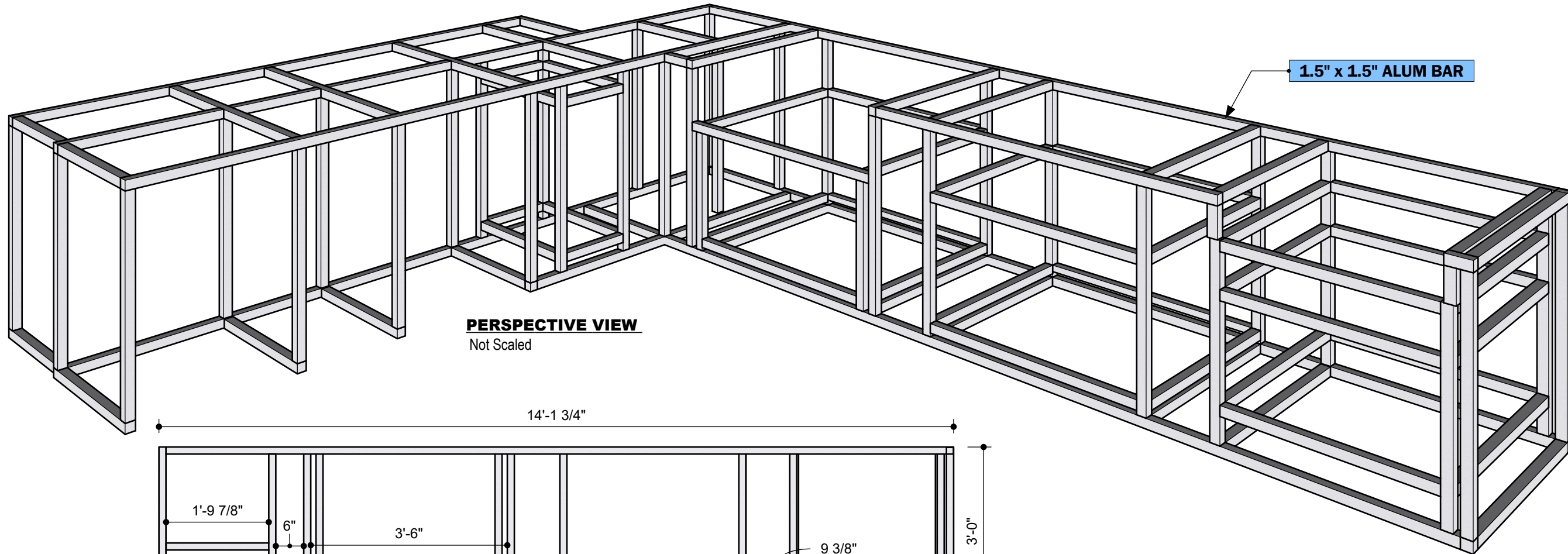

PERSPECTIVE VIEW
Not Scaled

14'-1 3/4"

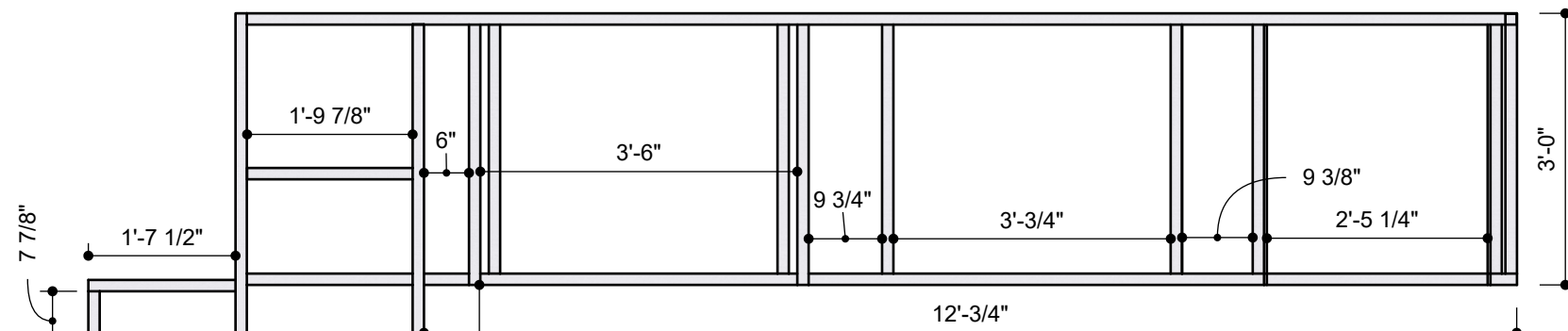

TOP VIEW
Scale 1:24



PROGRESS DRAWING

ALL MEASUREMENTS MUST BE VERIFIED IN FIELD
This drawing is not intended to be used for contract pricing or fabrication purposes. All content is subject to change

DISCARD ALL DRAWINGS THAT WERE MADE ON THIS ITEM PRIOR TO THE DATE BELOW:

02/18/2022

NOTES

Drawings may not be scaled. The numerical dimensions represent correct measurements. All dimensions are given from finished floor and finished wall unless otherwise noted. All design ideas, drawings and plans represented here are owned by the property of **WESTHAVEN CONSTRUCTION SERVICES**. All rights reserved. Above suggested electrical and plumbing locations, must be verified in field.

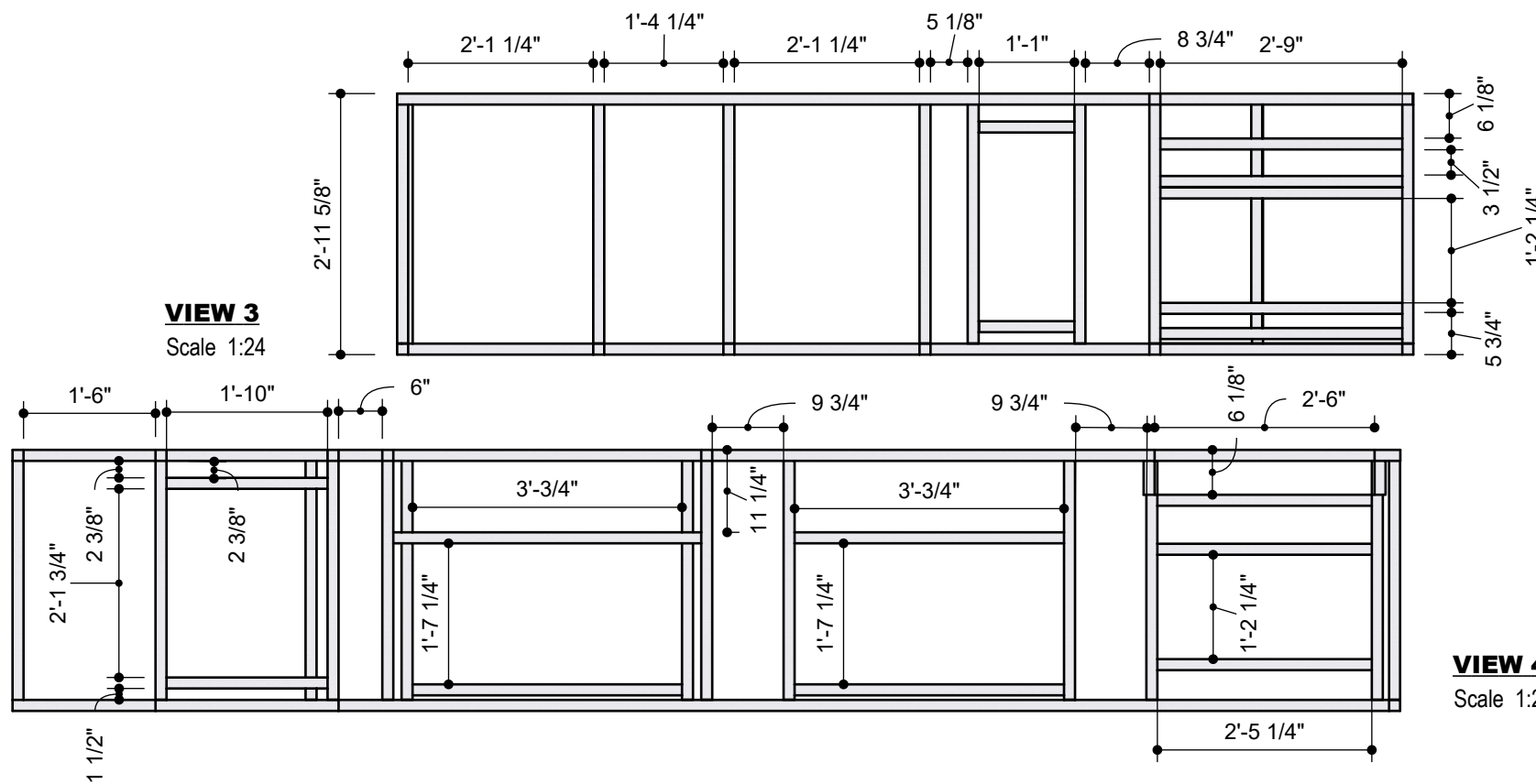

VIEW 3
Scale 1:24

VIEW 4
Scale 1:24