







Systems for Wall-Hung Toilets, 2x4 Installations



Dual-Flush Actuators

Dimensions: 9.75" x 6.5" (24.6 cm x 16.4 cm)

Style	Material	Finish	Model No.	List Price	
	Plastic	Alpine White	115.777.11.1	\$110.00	
		Polished Chrome	115.777.21.1	142.00	
		Matte Chrome	115.777.46.1	142.00	
	Plastic	Alpine White	115.770.11.5	81.00	
		Polished Chrome	115.770.21.5	110.00	
		Matte Chrome	115.770.46.5	110.00	
		Star White	115.770.FR.5	81.00	
		Br Ni-Polish-Br Ni*	115.778.ID.1	225.00	
	Metal	Br SS-Polish-Br SS*	115.778.SN.1	226.00	
		Br Ni-Polish-Br Ni* Vandal Resistant	115.781.ID.1	260.00	
		Br SS-Polish-Br SS* Vandal Resistant	115.781.SN.1	260.00	
		Plastic	Polish-Matte-Polish*	115.778.KH.1	167.00
			White-Polish-White*	115.778.KJ.1	116.00
			Black-Polish-Black*	115.778.KM.1	143.00
			NEW	Umber Glass	115.788.SQ.5
	Die Cast	Customer supplied inlay	115.788.00.5	334.00	
		Alpine White	115.788.11.5	334.00	
		Black	115.788.DW.5	334.00	
		Brushed Chrome	115.788.GH.5	431.00	
	Die Cast	White Pattern Glass	115.788.SC.5	431.00	
		Smoke Glass	115.788.SD.5	431.00	
		Green Satin Glass	115.788.SE.5	431.00	
		NEW	Umber Glass	115.788.SQ.5	431.00
		Complete Rough-in and Trim Set	115.792.GH.1	556.00	
	Glass	Rough-In Set***	115.795.21.1	167.00	
		Brushed Chrome Trim Set***	115.796.GH.1	389.00	
		NEW	Brushed SS	115.625.FW.1	625.00
	Glass	White Glass	115.625.SI.1	550.00	
		Black Glass	115.625.SJ.1	550.00	
		Umber Glass	115.625.SQ.1	550.00	



Single-Flush Actuators

Dimensions: 9.75" x 6.5" (24.6 cm x 16.4 cm)

	Die Cast	Alpine White	115.760.11.1	224.00
		Polished Chrome	115.760.21.1	224.00
		Matte Chrome	115.760.46.1	224.00
		Oil Rubbed Bronze	115.760.HM.1	378.00
		ForeverShine™ PVD Polished Nickel	115.760.IB.1	378.00
		ForeverShine™ PVD Brushed Nickel	115.760.ID.1	378.00
	Metal	Brushed Stainless with locking screw for vandal resistance	115.787.SN.5	260.00

Hands Free Actuators

Dimensions: 9.75" x 6.5" (24.6 cm x 16.4 cm)

	Glass	Black (AC Power)	116.091.SG.1	1,350.00
	Dual-Flush	Mirror (AC Power)	116.091.SM.1	1,350.00
		Transformer for AC powered hands free actuator.	115.861.00.1	132.00

Single-Flush Push Buttons

Dimensions: Square – 4.25" x 4.25" (10.8 cm x 10.8 cm)

Style	Material	Finish	Model No.	List Price
	Plastic	Alpine White	115.991.11.1	94.00
		Polish-Matte**	115.991.KA.1	143.00

Cover Plates for Sigma concealed tank 2x6 and 2x4 for use with Push Buttons

	Die Cast	Alpine White	115.765.11.1	171.00
		Matte Chrome	115.765.46.1	171.00
	Metal	Brushed SS	115.798.00.1	135.00

Geberit Duofix Carrier

Model No.	Description	List Price
111.728.00.1	Carrier frame with Sigma concealed tank, 2x4 installations	\$646.00

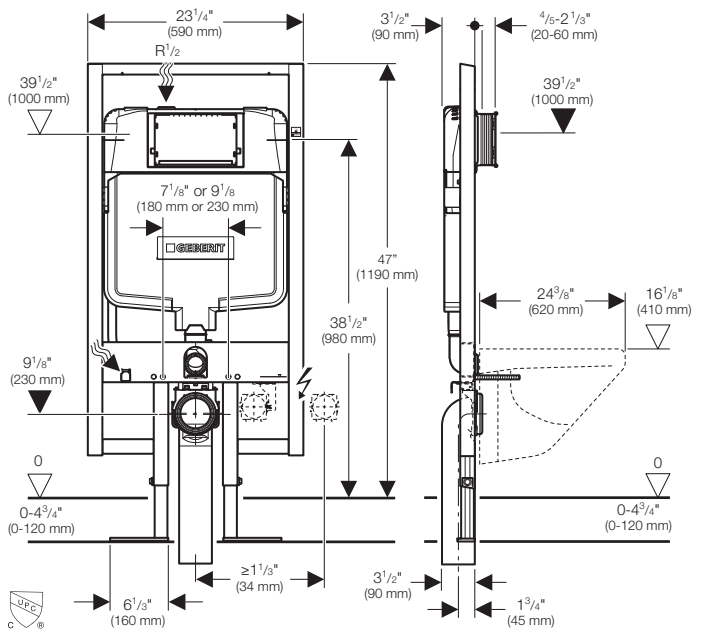



- NOTES:
1. Concealed tank shipped dual-flush ready
 2. Geberit Duofix Carrier for 2-hole washdown style wall-hung toilet fixtures only
 3. Refer to → geberit.us for latest list of Code approved Compatible toilet fixtures, including certified WaterSense combinations

* Finishes follow this pattern = Plate-Ring-Button
 ** Finishes follow this pattern = Frame-Button
 Polish = Polished Chrome
 Matte = Matte Chrome
 Br SS = Brushed Stainless Steel
 Br Ni = Brushed Nickel





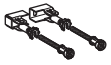
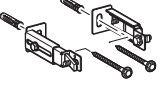

*** Rough-in Set and Trim Set can be ordered separately. Both sets needed for installation.
 † Note: For tiled walls only!

Optional Accessories





Mounting Accessories for Geberit Duofix Carrier Frames

Description	Model No.	List Price
 Frame to wall anchoring for 5.125"-7.875" (13-20 cm) thick unfinished pre-wall corner installations	111.835.00.1	\$31.00
 Frame to wall anchoring where foot installations into floor are not allowed for 5.125"-7.875" (13-20 cm) thick unfinished pre-wall	111.867.00.1	62.00
 Frame to wall anchoring extensions for 7.875"-15.75" (20-40 cm) thick unfinished pre-wall	111.887.00.1	12.00
 Frame to wall anchoring for 5.125"-7.875" (13-20 cm) thick unfinished pre-wall	242.048.00.1	20.00



Waste Fittings

 HDPE straight connector with socket for 03.50" (090 mm) push fit piping and 03.50" (090 mm) outlet x 12" (31 cm) long	366.887.16.1	31.00
 HDPE connector with offset for LH horizontal drain connections (as viewed from sitting position), 1 x 90° bend with socket for 03.50" (090 mm) push fit piping, with 45° offset and 03.50" (090 mm) outlet for 5.5" (13.97 cm) minimum walls only.	366.913.16.1	68.00
 HDPE connector with offset for RH horizontal drain connections (as viewed from sitting position), 1 x 90° bend with socket for 03.50" (090 mm) push fit piping, with 45° offset and 03.50" (090 mm) outlet for 5.5" (13.97 cm) minimum walls only.	366.914.16.1	68.00
 Cast iron outlet bend; 1 x 90° bend with socket for 03.50" (090 mm) push fit piping and 3" CIP outlet	367.071.18.1	140.00
 HDPE "Back-to-back" connector for horizontal drain connections; 2 x 90° bends with sockets for 03.50" (090 mm) push fit piping, with 45° offset and expansion to 04.375" (0110 mm) outlet for 10.75" (27.31 cm) minimum walls only.	367.485.16.1	140.00
 HDPE "Back-to-back" connector for vertical drain connections; 2 x 90° bends with sockets for 03.50" (090 mm) push fit piping and expansion to 04.375" (0110 mm) outlet for 10.75" (27.31 cm) minimum walls only.	367.923.16.1	140.00



Bowl Connection Sets and Accessories for Finished Walls up to 3.5" (9cm) Thick

Description	Model No.	List Price
 Connector set with mounting hardware (bowl installation kit), HDPE; Alpine White cover caps	152.404.11.1	39.00
 HDPE connection set with 1" (2.5 cm) offset and mounting hardware (bowl installation kit); with socket for 03.50" (090 mm) push fit piping and 055 supply inlet; Matte Chrome cover caps	405.116.00.1	208.00
 Cover caps with leveling washer, Plastic, Alpine White	217.713.11.1	5.00
 Acoustic insulation set for wall-hung toilets and bidets	156.050.00.1	16.00

Bidet Seat Accessories for Geberit Duofix Carrier Frames

 Water supply hose for bidet seat for 111.728.00.1 carrier with Sigma concealed tanks 2x4. For adding bidet seat to an installed carrier. For complete installation order with 249.801.00.1.	242.413.00.1	43.00
 Water supply hose for bidet seat for 111.355.00.5, 111.728.00.1 and 111.255.00.1 carriers with Sigma concealed tanks 2x6 and 2x4 and Kappa concealed tank. For adding bidet seat to an installed carrier.	249.801.00.1	101.00

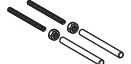
Required Accessories for 3.50"-7.00" (9-18 cm) Finished Wall Thickness

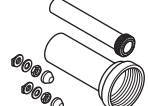
 Mounting rod extension set for wall-hung toilet and bidet, M12	242.232.00.1	61.00
 Mud guard protection housing for Sigma concealed tanks 2x6 and 2x4, Plastic	241.826.00.1	11.00
 Extension set for actuator plates for Sigma concealed tanks 2x6 and 2x4 and Kappa concealed tank	240.938.00.1	20.00
 HDPE Connector set for extended installation and mounting hardware (bowl installation kit), with socket for 03.50" (090 mm) push fit piping and 055 supply inlet; Matte Chrome cover caps	152.438.46.1	51.00