

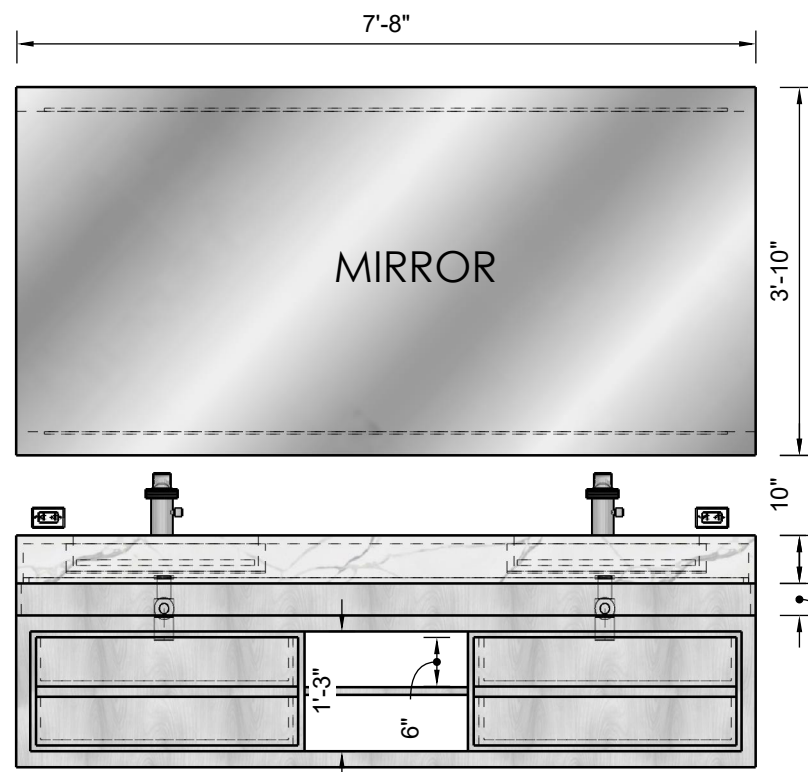

**SECTION A**

Scale 1:24



**FRONT VIEW**

Scale 1:24

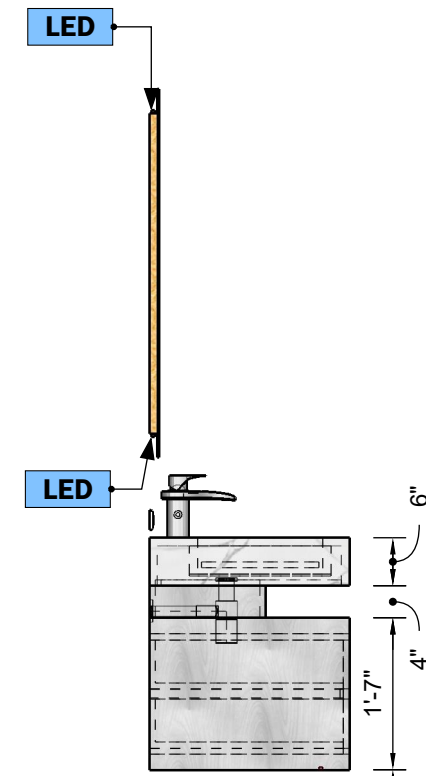

**SIDE VIEW**

Scale 1:24

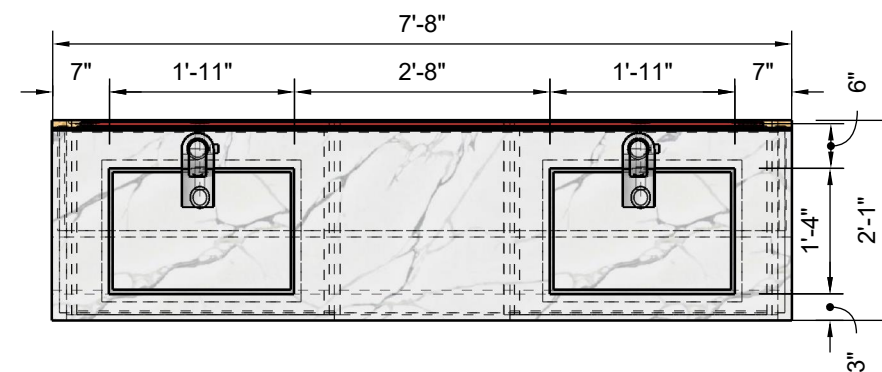

**TOP VIEW**

Scale 1:24

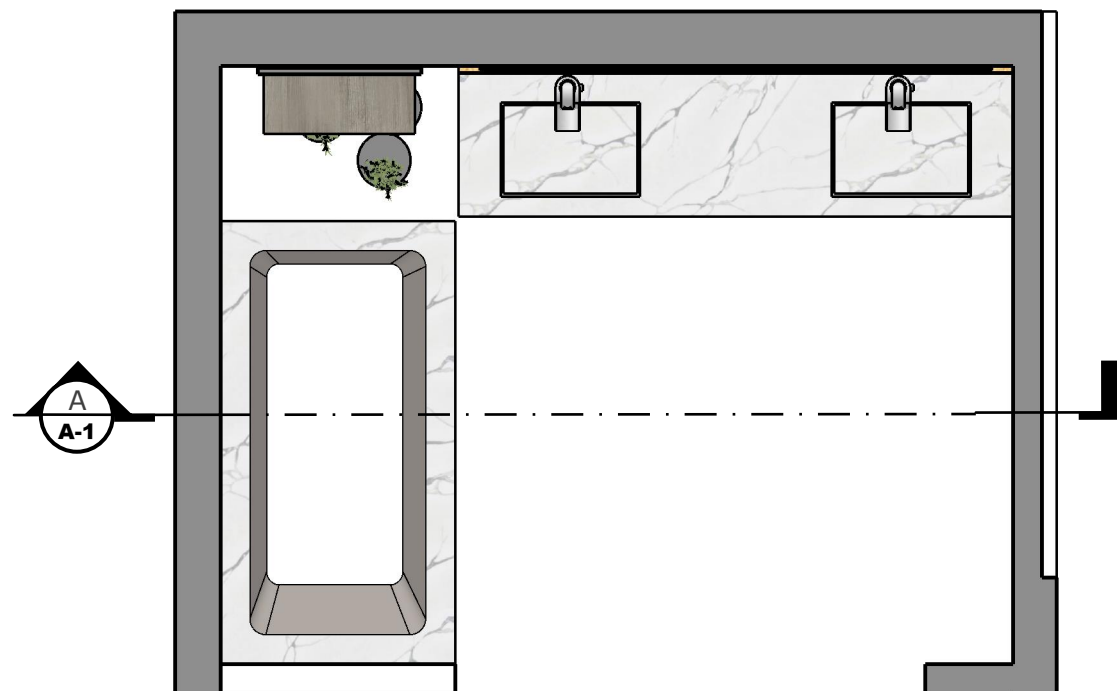

**TOP VIEW**

Scale 1:32

*This plan presents preliminary proposals for materials, measurements, and design. Please note that these proposals are subject to possible changes.*

**Materials:** Proposed materials are subject to evaluation and final selection.

**Measurements:** Indicated measurements are approximate and may be adjusted during the design and construction process.

**Design:** The presented design is an initial proposal and may undergo modifications.

**Approvals and revisions:** Any changes to materials, measurements, or design require appropriate approval.

*This plan does not represent the final version of the project, and adjustments will be made to ensure quality and goal fulfillment.*

**NOTE**

Drawings may not be scaled.

The numerical dimensions represent correct measurements. (If not indicated, the precision of the dimensions by default is to 1")

All design ideas, drawings and plans represented here are owned by the property of WESTHAVEN CONSTRUCTION SERVICES, INC. All rights reserved. Above suggested electrical and plumbing locations, must be verified in field.



**WESTHAVEN**  
CONSTRUCTION SERVICES, INC.

8254 South River Dr  
Medley, FL 33166  
Ph. 305 556 1416  
www.westhavencn.com

**PROGRESS DRAWING  
FOR APPROVAL**



CONTACT DESIGN TEAM

**BASE VERSION**

SUBJECT TO REVISIONS

ISSUE 05/ 3/ 2024  
RE - ISSUE 05/3/2024

**2805 JADE SIGNATURE**  
0000 Fl, 33000

DESIGN BY J. Alonso  
OWNER MAS  
DRAWN BY A. Quintero  
PAGE NAME VANITY

**DESIGN CONCEPT**

**ALL MEASUREMENTS  
MUST BE  
VERIFIED IN FIELD**

DISCARD ALL DRAWINGS THAT  
WERE MADE ON THIS ITEM PRIOR  
TO THE DATE BELOW:

**05/3/2024**

This drawing is not intended to be used  
for contract pricing or fabrication  
purposes.  
All content is subject to change

**D - 01**

MASTER  
BATHROOM

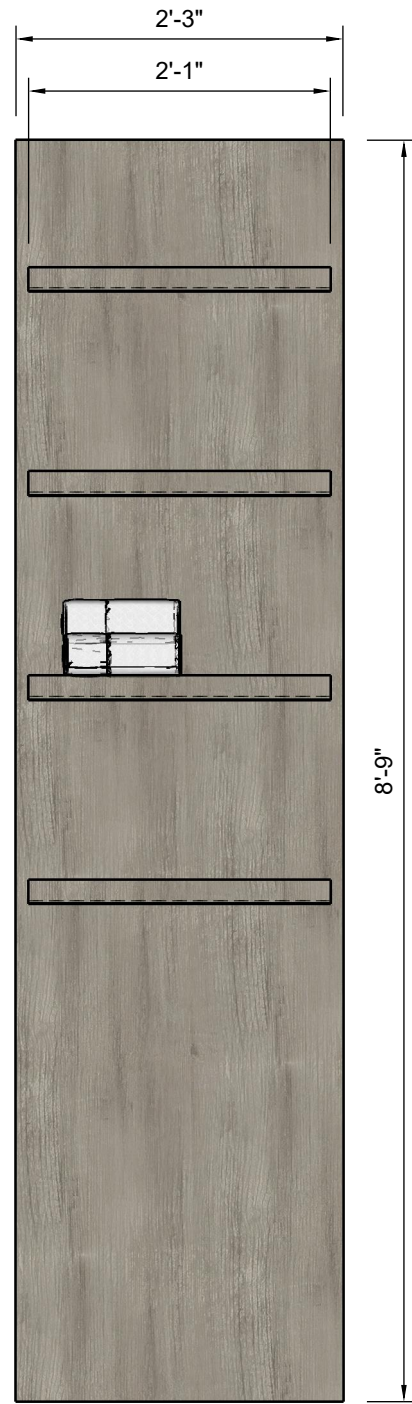

**FRONT VIEW**

Scale 1:16

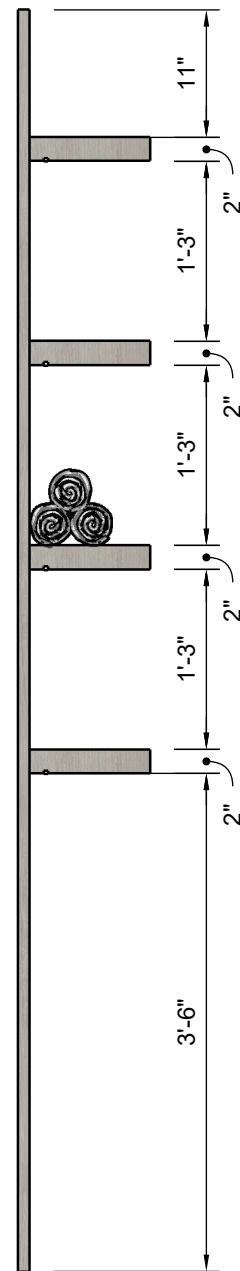

**SIDE VIEW**

Scale 1:16



**TOP VIEW**

Scale 1:16

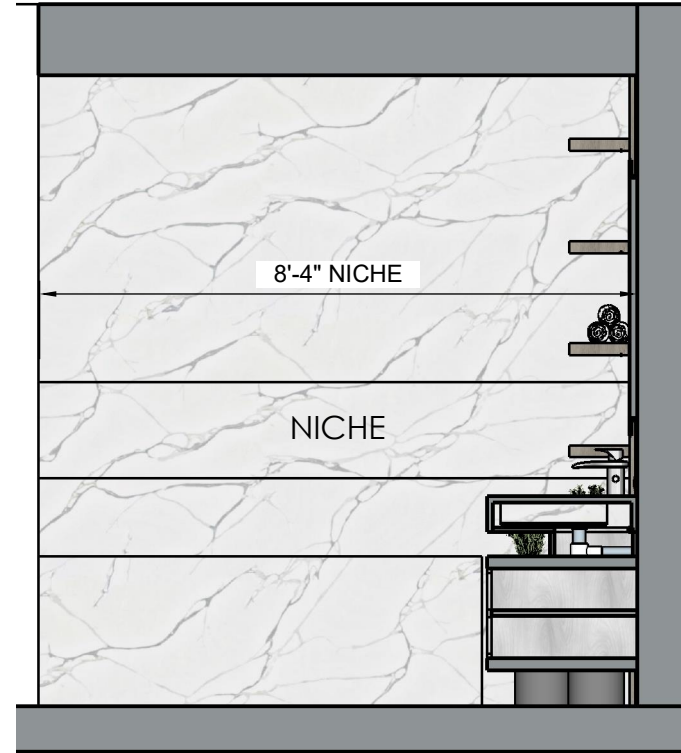

**SECTION B**

Scale 1:00

*This plan presents preliminary proposals for materials, measurements, and design. Please note that these proposals are subject to possible changes.*

**Materials:** Proposed materials are subject to evaluation and final selection.

**Measurements:** Indicated measurements are approximate and may be adjusted during the design and construction process.

**Design:** The presented design is an initial proposal and may undergo modifications.

**Approvals and revisions:** Any changes to materials, measurements, or design require appropriate approval.

*This plan does not represent the final version of the project, and adjustments will be made to ensure quality and goal fulfillment.*

T.B.D	SELLER
MATERIAL NAME	
Item No:	

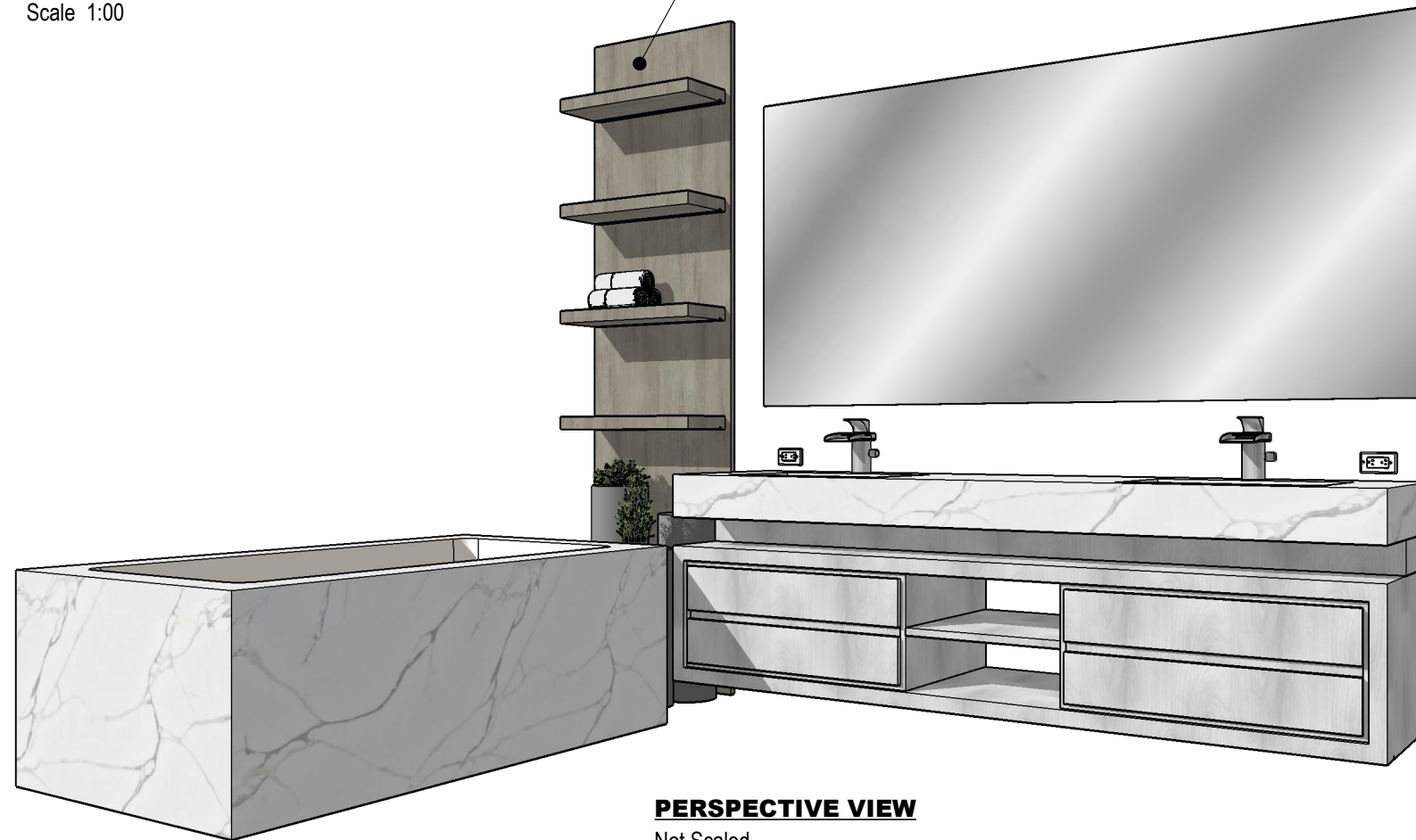

**PERSPECTIVE VIEW**

Not Scaled

