

3701 MIRAMAR

KITCHEN CABINETRY

Sheet #	Sheet Name
Sheet A1	Cover Page
Sheet A2	TOP VIEW
Sheet A3	CABINETS ELEVATIONS
Sheet A4	ISLAND
Sheet A5	SINKS SPECS
Sheet A6	BREAKFAST TABLE



PROGRESS DRAWING

This presentation is not intended to be used for contract pricing or fabrication purposes. All content is subject to change.

DISCARD ALL PRESENTATIONS THAT WERE MADE ON THIS ITEM PRIOR TO THE DATE BELOW:

07/20/2022

NOTES

The drawings included in presentations may not be scaled. The numerical dimensions represent correct measurements. All dimensions are given from finished floor and finished wall unless otherwise noted. All design ideas, drawings and plans represented here are owned by the property of WESTHAVEN CONSTRUCTION SERVICES. Above suggested electrical and plumbing locations, must be verified in field.

PROJECT

**3701
MIRAMAR**

PAGE NAME

Cover Page

DESIGN BY

J. ALONSO

DRAWING BY

A. QUINTERO

CREATED

08/ 13/ 2021

MODIFIED

07/20/2022

CLIENT

JOEL & YOLY ALONSO

ADDRESS

0000
FL, 33000



WESTHAVEN
CONSTRUCTION SERVICES, INC.

8254 NW SOUTH RIVER DRIVE, MEDLEY, FL 33166
All rights reserved.



TOP VIEW
Scale 1:24

FINISH	SELLER
AUBURN CARINI WALNUT	
Item No:	

PROGRESS DRAWING

This drawing is not intended to be used for contract pricing or fabrication purposes. All content is subject to change.

DISCARD ALL DRAWINGS THAT WERE MADE ON THIS ITEM PRIOR TO THE DATE BELOW:

07/20/2022

NOTES

Drawings may not be scaled. The numerical dimensions represent correct measurements. All dimensions are given from finished floor and finished wall unless otherwise noted. All design ideas, drawings and plans represented here are owned by the property of **WESTHAVEN CONSTRUCTION SERVICES**. All rights reserved. Above suggested electrical and plumbing locations, must be verified in field.



WESTHAVEN
CONSTRUCTION SERVICES, INC.

CLIENT
JOEL & YOLY ALONSO
0000

ISSUE
08/13/2021
RE - ISSUE
MM,DD,YY

DESIGN BY
Joel A.
DRAWN BY
Abel Q.

DESCRIPTION
KITCHEN CABINETRY
PAGE NAME
TOP VIEW

PROJECT No
3701
PROJECT NAME
MIRAMAR

A-01



PROGRESS DRAWING

This drawing is not intended to be used for contract pricing or fabrication purposes. All content is subject to change.

DISCARD ALL DRAWINGS THAT WERE MADE ON THIS ITEM PRIOR TO THE DATE BELOW:

07/20/2022

NOTES

Drawings may not be scaled. The numerical dimensions represent correct measurements. All dimensions are given from finished floor and finished wall unless otherwise noted.

All design ideas, drawings and plans represented here are owned by the property of **WESTHAVEN CONSTRUCTION SERVICES**. All rights reserved.

Above suggested electrical and plumbing locations, must be verified in field.

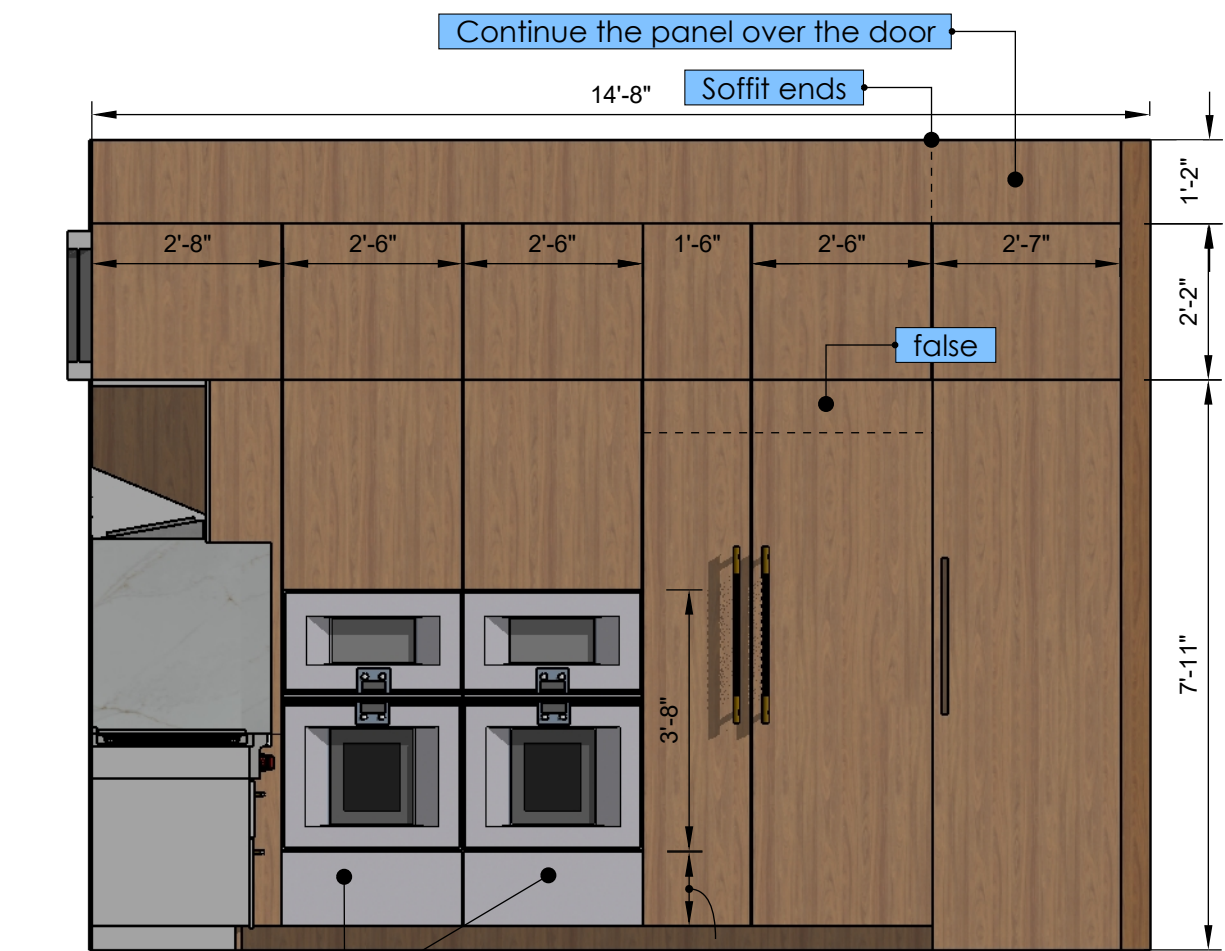
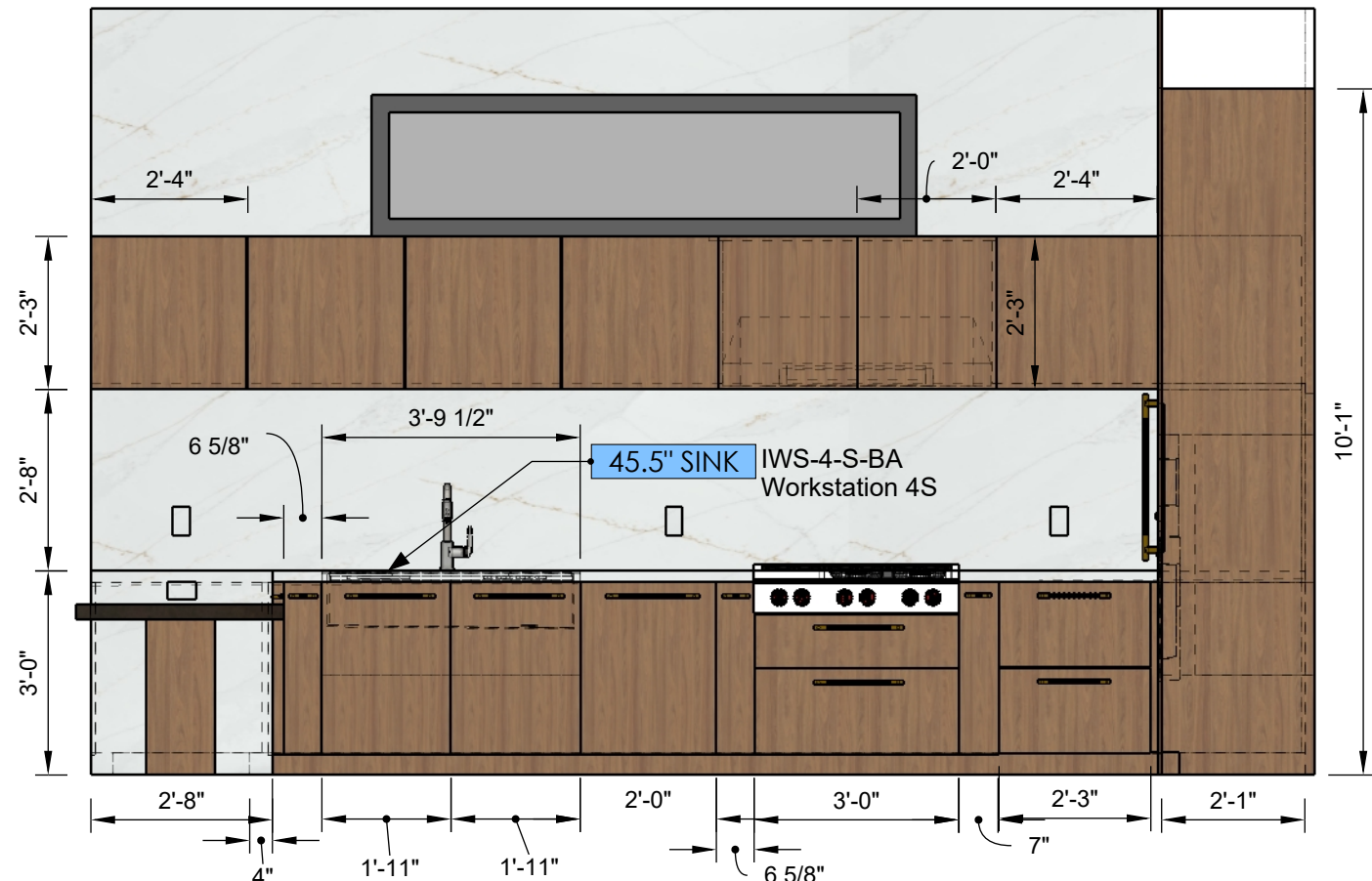

02 WARMERS DRAWERS

SECTION 3

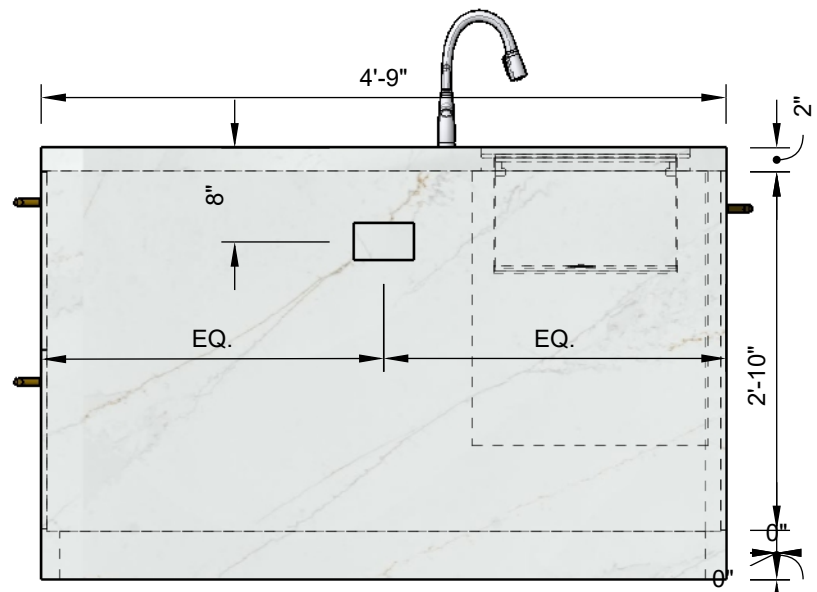

VIEW (2)

Scale 1:32



Result

Tiles Needed: 4 Pieces
Boxes Needed: 4 Boxes

Purchase 5% - 10% more (4 - 4 tiles, 4 boxes) for cutting, waste, and possible future repairs.

Tile Size: Length inches
 Width inches

Area to Cover: Use Dimensions Use Total Area

Total Area square feet

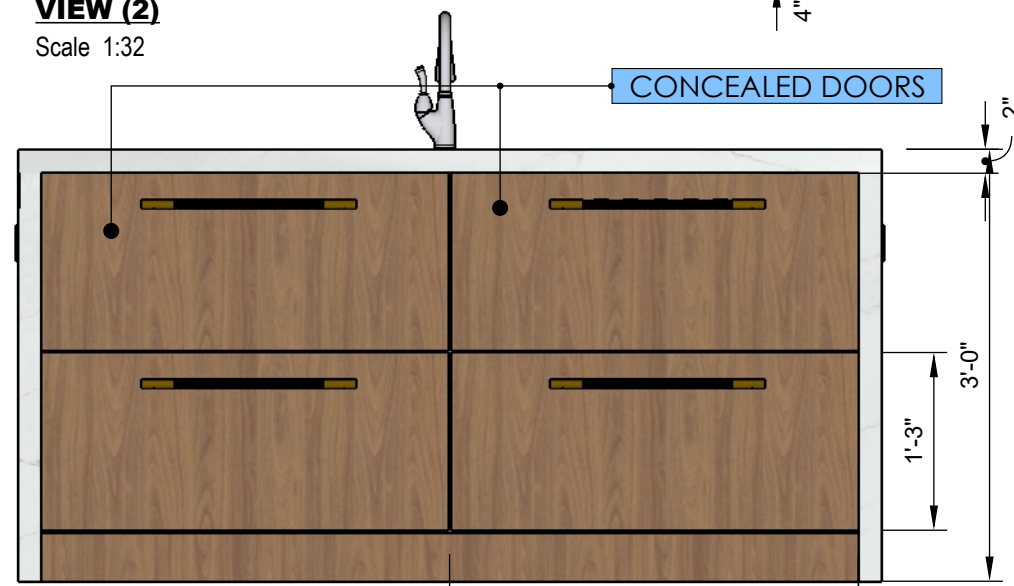

VIEW (3)

Scale 1:32

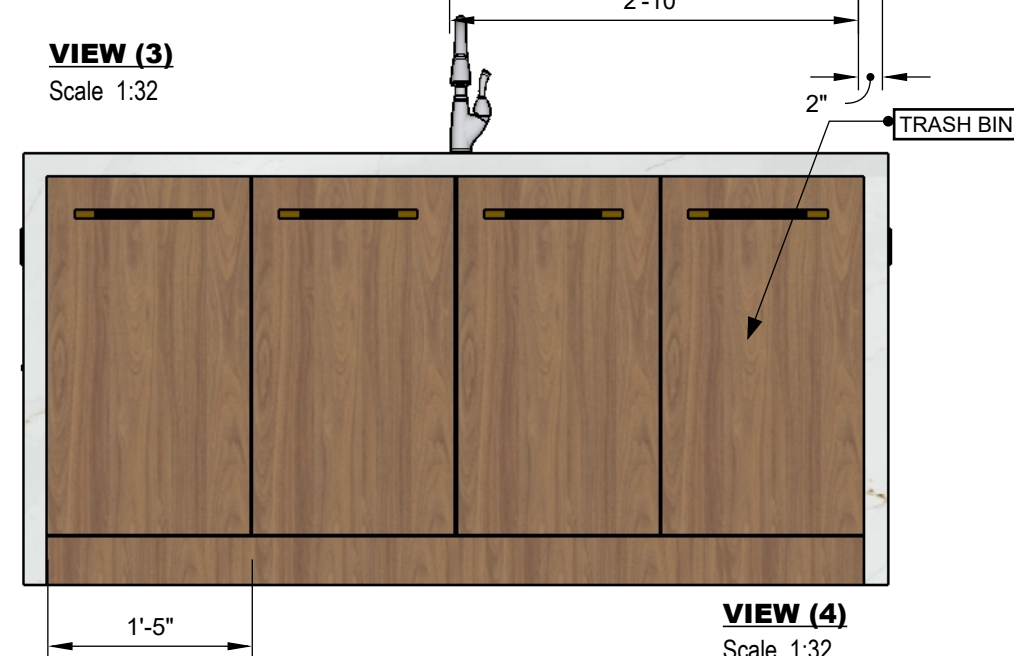

VIEW (4)

Scale 1:32

PROGRESS DRAWING

This drawing is not intended to be used for contract pricing or fabrication purposes. All content is subject to change.

DISCARD ALL DRAWINGS THAT WERE MADE ON THIS ITEM PRIOR TO THE DATE BELOW:

07/20/2022

NOTES

Drawings may not be scaled. The numerical dimensions represent correct measurements. All dimensions are given from finished floor and finished wall unless otherwise noted.

All design ideas, drawings and plans represented here are owned by the property of **WESTHAVEN CONSTRUCTION SERVICES**. All rights reserved. Above suggested electrical and plumbing locations, must be verified in field.

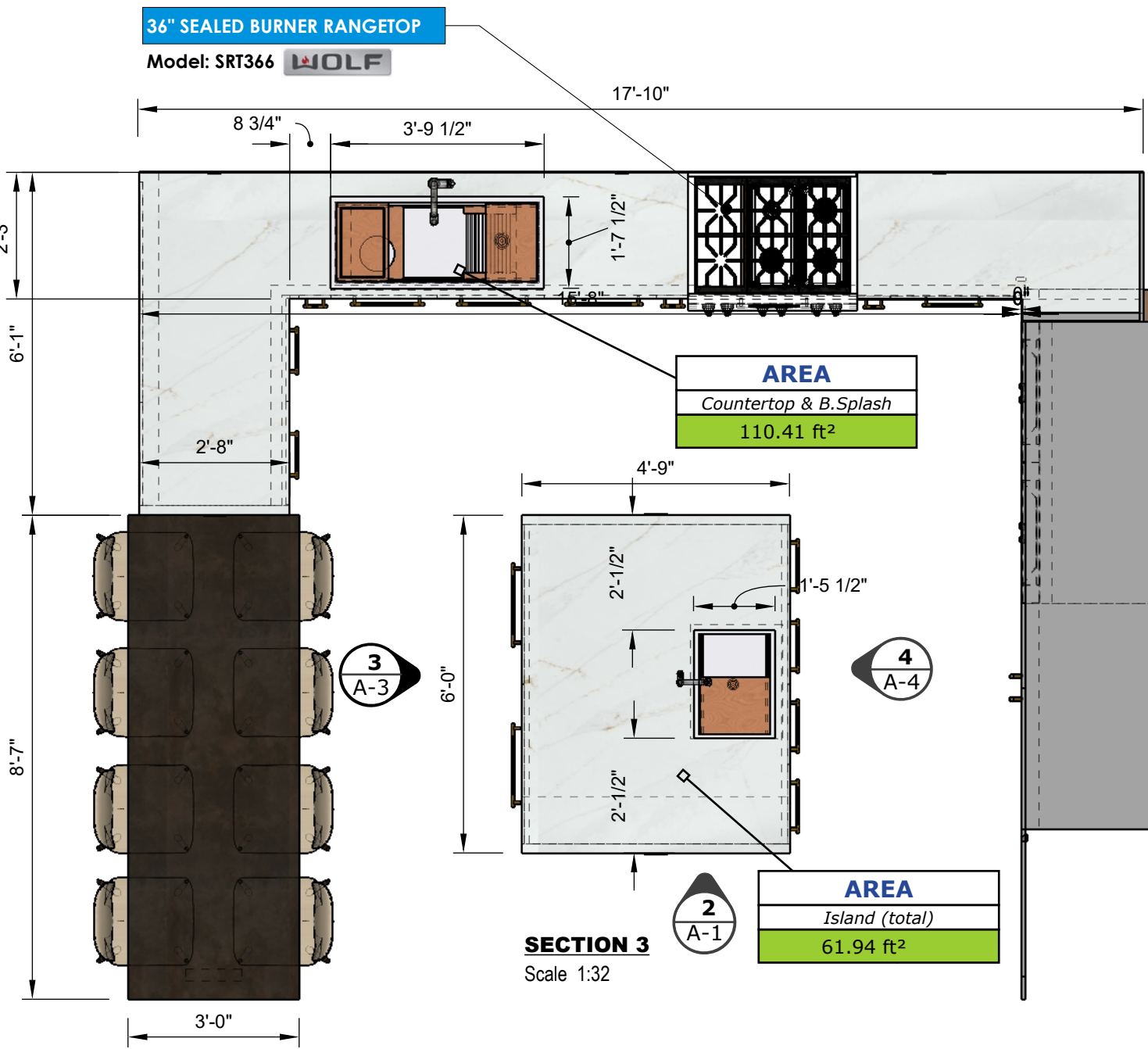

SECTION 3
Scale 1:32

AREA
Countertop & B.Splash
110.41 ft²

AREA
Island (total)
61.94 ft²

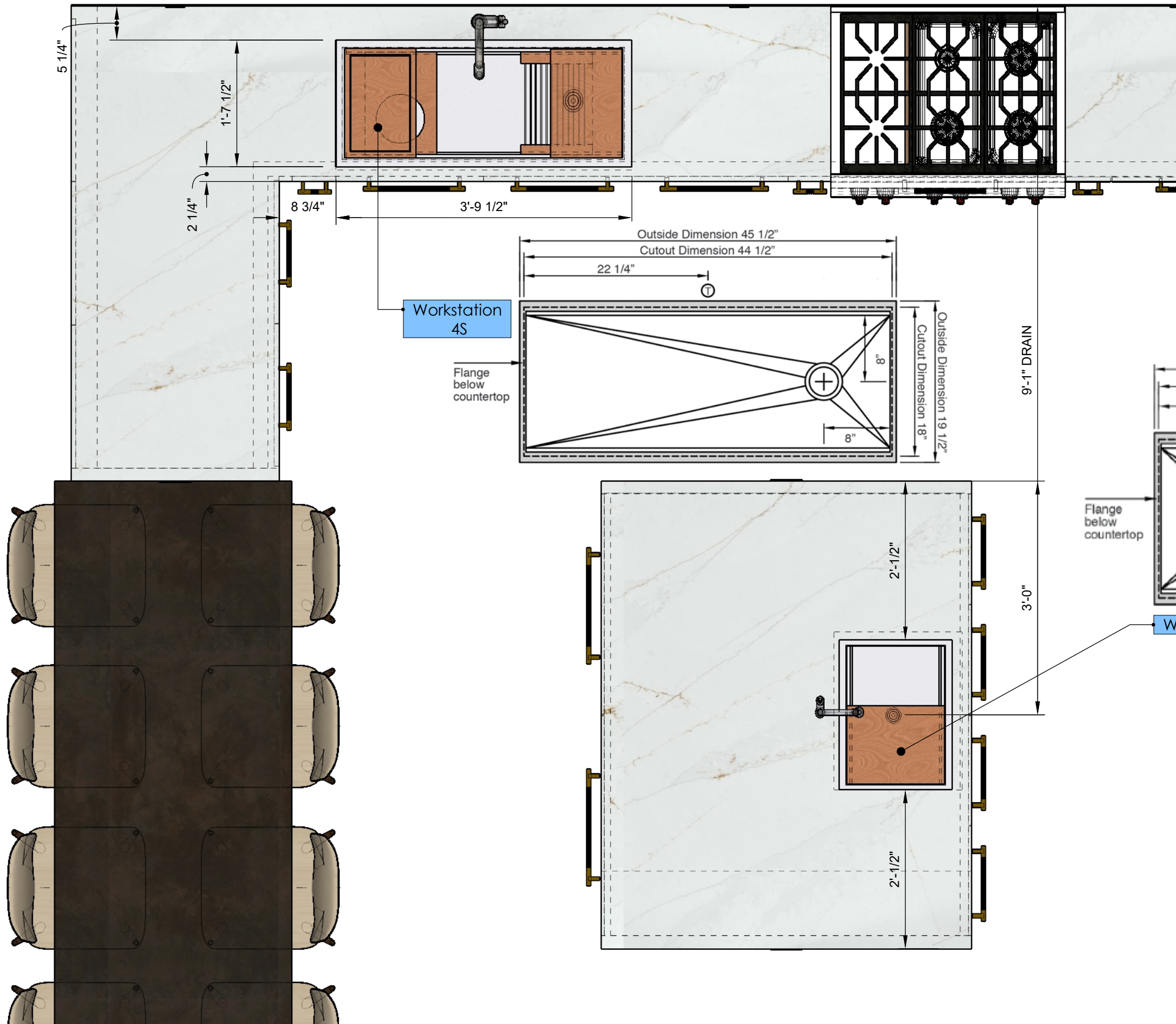

PROGRESS DRAWING

This drawing is not intended to be used for contract pricing or fabrication purposes. All content is subject to change.

DISCARD ALL DRAWINGS THAT WERE MADE ON THIS ITEM PRIOR TO THE DATE BELOW:

07/20/2022

NOTES

Drawings may not be scaled. The numerical dimensions represent correct measurements. All dimensions are given from finished floor and finished wall unless otherwise noted. All design ideas, drawings and plans represented here are owned by the property of **WESTHAVEN CONSTRUCTION SERVICES**. All rights reserved. Above suggested electrical and plumbing locations, must be verified in field.

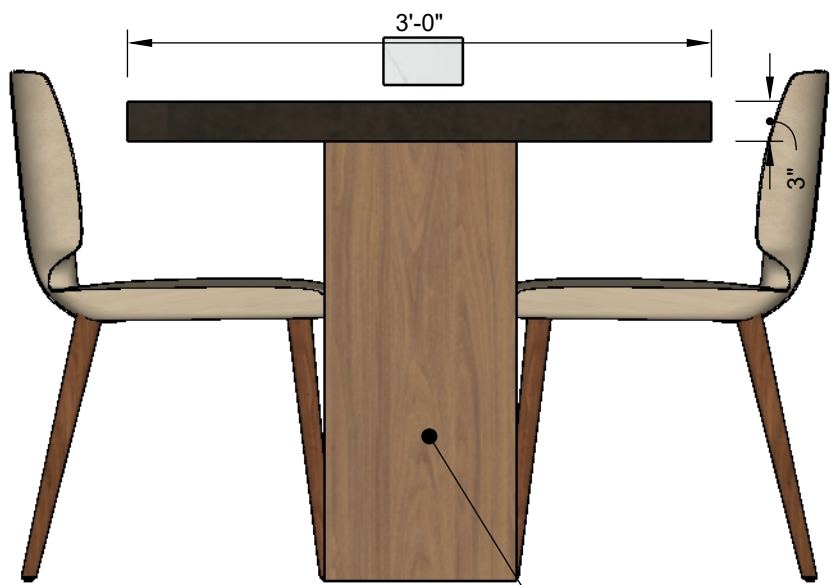

FRONT VIEW
Scale 1:12

FINISH
AUBURN CARINI
WALNUT

AREA
Table top
29.53 ft ²

TRUFIG

FINISH
DEKTON
KERANIUM

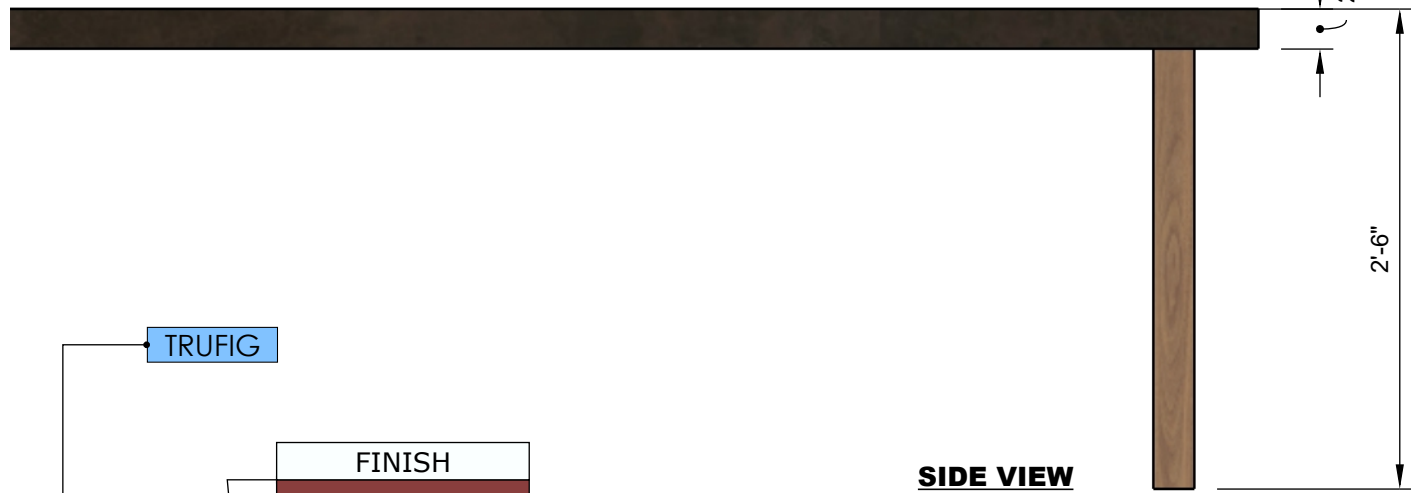

SIDE VIEW
Scale 1:16



SIDE TABLE
PERSPECTIVE VIEW
Not Scaled

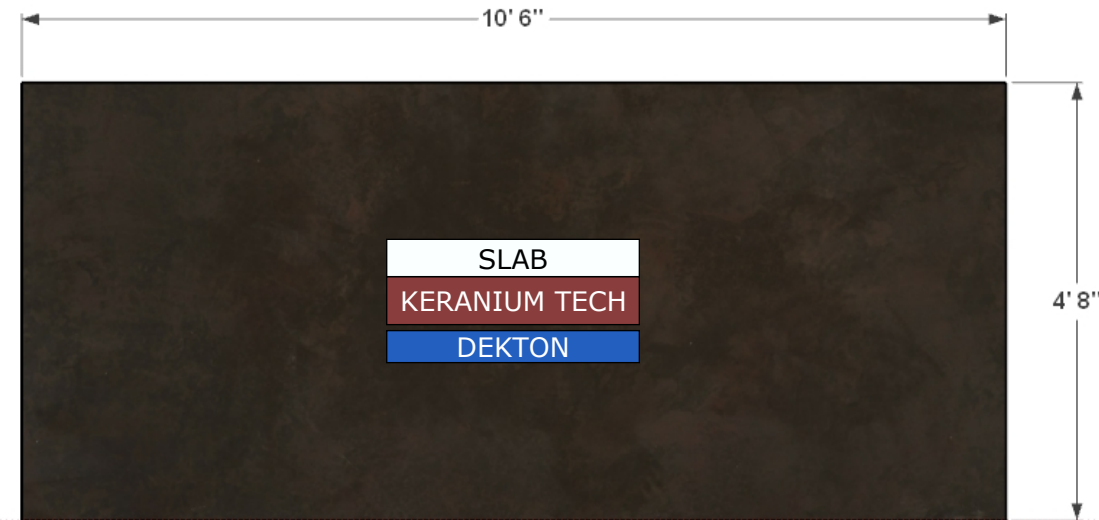

SLAB
KERANIUM TECH
DEKTON

Result

Tiles Needed: 1 Pieces
Boxes Needed: 1 Boxes

Purchase 5% - 10% more (1 - 1 tiles, 1 boxes) for cutting, waste, and possible future repairs.

Tile Size: Length inches inches

Area to Cover: Use Dimensions Use Total Area

Total Area square feet

